

m  
Materasso

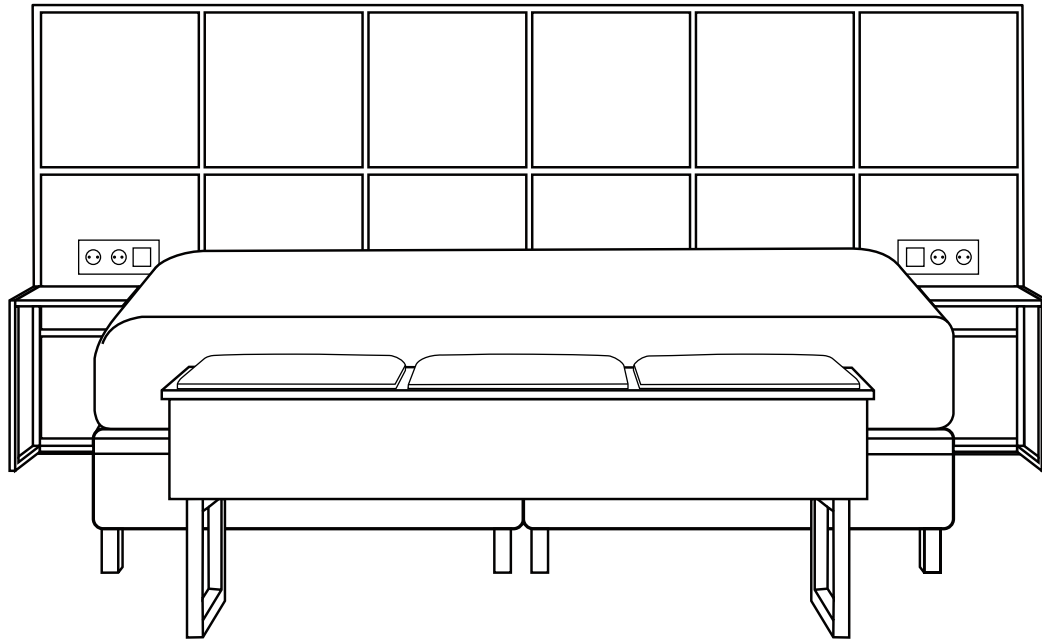

m  
Materasso

- |                      |                  |
|----------------------|------------------|
| 11 DAMIANI SET       | 48 HORIZONTAL    |
| 13 CRISTAL SET       | 50 NAVY          |
| 15 SPECTRA SET       | 52 ENIF          |
| 17 CORONA SET        | 54 GEMINI        |
| 19 FRANCESCA LUX SET | 57 FRANCESCA LUX |
| 21 SOUL SET          | 59 CLAUDIA LUX   |
| 23 CRISTAL           | 60 ALESIA        |
| 25 LA SPEZIA         | 63 VEGA          |
| 27 DAMIANI           | 65 BELLATRIX     |
| 29 SOUL              | 66 ATLAS         |
| 31 CORIUM            | 68 CORONA        |
| 35 CHESTERFIELD      | 70 PARIS         |
| 37 RHOMBUS           | 72 VIENNA        |
| 39 WILD              | 74 NOBILIA       |
| 41 KINGSTONE         | 77 ARGENTINA     |
| 43 HONEY             | 79 SIRIUS        |
| 44 MELVA             | 81 VELORUM       |
| 46 SPECTRA           |                  |

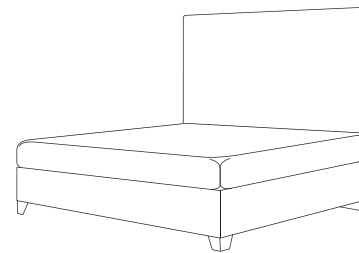

- 83 WALL
- 85 TWINS
- 87 SOFABED DOUBLE
- 89 SOFABED SINGLE

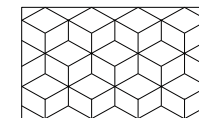

- 90 BOUDOIR MONT BLANC
- 91 MONT BLANC
- 92 BOSS
- 93 MOON
- 94 BOUDOIR BREEZE
- 95 BREEZE
- 96 DE LUXE
- 97 MODERN

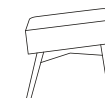
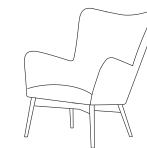

- 99 INDUSTRY
- 99 HEAVY OAK
- 99 OAK
- 100 WHITE
- 100 STONE
- 100 DARK STONE
- 101 CUBE
- 101 BIANCA

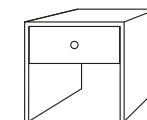

- 102 TABURET BENCH

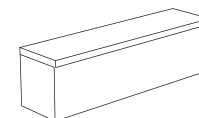

- 105 ACCESORIES



# m Materasso

*Pro chvíle, na kterých záleží...*

**Společnost Materasso s. r. o. je rodinná firma**, která je na trhu již více než 25 let. Na českém i evropském trhu a v posledních letech i na trzích mimoevropských je známá výrobou certifikovaných zdravotních matrací, designových postelí, interiérových doplňků (taburety, křesla, noční stolky...) a postelových doplňků (přikrývky, polštáře, matracové chrániče).

Díky neustále se rozrůstajícímu sortimentu našich výrobků, použití kvalitních materiálů, dodržování certifikovaných výrobních postupů a následnému servisu rozšiřujeme řady spokojených zákazníků. A to běžných klientů i profesionálů (interiérových designérů nebo hoteliérů).

Stavíme na silném týmu kvalifikovaných odborníků s dlouholetými zkušenostmi v oblasti výroby ortopedických matrací a postelí a zároveň na kvalitě našich výrobků. Nabízíme možnost kombinace různých spacích systémů s bohatým výběrem moderních čel postelí, v různých designech a způsobech zpracování.

Vyrábíme různé typy korpusů postelí s užšími nebo silnějšími bočnicemi, posteje ve standardní i atypické délce, v pohodlných boxspringových verzích známých především z hotelů. Zákazník si může zvolit verzi bez nebo s úložným prostorem. Individuální je i výběr roštů od klasických pevných, s výklapem nebo s elektrickým pohonem polohování. Neustále sledujeme nové technologie a trendy v interiérovém dizajnu. Ich následná aplikace do výroby nám umožnila vytvořit ucelenou a designově zdařilou kolekci postelí i celých ložnicových setů. Design a styl postelí je umocněn použitím kvalitních čalounických potahových látek.

V naší nabídce najdete nejen látky s originálními vzory a strukturami, ale také látky se speciální úpravou pro snadné čištění, látky odolávající absorpci tekutin a nečistot. Každou postel z nabídky (v jakémkoliv provedení korpusu), je možné doladit vhodným výběrem nožiček v rozmanitých provedeních ať už jde o materiál, tvar nebo výšku.

**Ložnice** je nejintimnějším a nejdůležitějším místem ve Vaší domácnosti. Je to místo odpočinku a relaxace těla i všech smyslů po celodenní námaze. Tam získáváte sílu a připravujete se na nové výzvy. Uvědomujeme si, že ústředním bodem ložnice je postel, která jí dává duši i charakter.

Proto kolekci našich postelí charakterizuje nejen pevná konstrukce a perfektní vypracování, ale zároveň i krásný design, bohatý výběr potahových látek a jejich barevného provedení. Ve spojení s nabídkou našich zdravotních matrací Vám poskytne komfort a pohodlí té nejvyšší úrovně. Velký důraz klademe na funkčnost a možnost vytvoření modelů postelí přesně podle Vašich představ. Díky velkému množství variací v nabídce tvarů a designů, také barev a doplňkových funkcí, určitě najdete v naší nabídce postel, kterou dotvoříte styl Vašeho interiéru tak, aby se ložnice stala nejútulnějším místem ve Vašem domě.



## POSTELOVÉ SYSTÉMY

Každý postelový systém je možné kombinovat s libovolným čelem postele a nožičkami. Můžete si vybrat z velké nabídky kvalitních čalounických látek. Ke každé posteli je možné objednat i taburet, křeslo nebo podnožku ke křeslu ve stejné látce. Výšky spacích systémů jsou uvedeny bez nožiček. Všechny postele v rámci dětského a teenager programu vyrábíme už od šířky 90 cm. Celý korpus postele (bez čela a roštů) je balený v kartónové krabici, což zjednodušuje přepravu a zlepšuje ochranu při manipulaci. Ve všech montovaných spojích u rámových korpusů jsou použity matice a šrouby s metrickým závitem, umožňující i opětovnou bezproblémovou montáž.

**Boxspring 22/32 cm** je nejpokrokovějším postelovým systémem.

Jeho oblíbenost je dána specifickou konstrukcí: masivní rám boxspringu obklopuje pružinovou kostru, která zajišťuje bodově přizpůsobivý podklad pod matrací, zlepšuje kopírovací vlastnosti a celkovou přizpůsobivost použité matrace. Takové složení vytváří výjimečný systém dvojího kopírování přirozeného tvaru těla. Boxspring je čalouněný ve stejné látce jako čelo postele a na ložné ploše boxspringu je speciální potahová látka s úpravou ANTISLIP, dokonale fixující matraci proti posunu. Výška bočnice boxspringu je 22 nebo 32 cm. Matrace není zapuštěná do rámu postele, ale lícuje s boxspringem



**Boxspring Mobil** – konstrukce shodná s boxspringem 22/32 je doplněna o funkci plynulého polohování hlavy, zádové části a nohou pomocí elektromotoru s ovládačem. Tento typ postelí nemá vystupující bočnice a polohování umožňuje nastavení nejlepší pozice pro odpočinek - jiná je poloha pro spaní, jiná pro aktivní odpočinek (např. čtení), jiná při regeneraci bolavých nohou. Boxspring Mobil ideálně spolupracuje s matracemi ze studených pěn, s anatomicky prořezanými jádry, latexovými matracemi a také matracemi z „líných“ termo–elastických pěn. Tyto matrace přesně kopírují tvar roštu při polohování. Výška boxspringu je 32 cm.



**Boxspring výklop UP MAXI 40 a UP MAXI 100** - je ideálním řešením pro všechny, kteří hledají komfortní postel s přednostmi boxspringu, která je doplněna o velký úložný prostor uvnitř postele. Boxspringová konstrukce zmenšuje požadavky na prostor v ložnici a dovoluje použít i rozměrově větší matraci oproti tradičnímu typu postele. Úložný prostor je řešen bez vnitřních dělicích příček a tím poskytuje výjimečně velký odkládací prostor s výborným přístupem po celé ploše. S boxspringem UP MAXI 40 budete bez problémů zvedat matraci do celkové hmotnosti 40 kg. Pro matrace s vyšší hmotností je určen systém UP MAXI 100. Ten disponuje 4 ks kování a pístů pro snadné zvedání víka úložného prostoru spolu s těžkými matracemi z kvalitních materiálů vysoké objemové hustoty. Výška boxspringu je 32 cm. Matrace lícuje s boxspringem.



**Box výklop UP maxi elektric** nabízí komfortní přístup do úložného prostoru díky elektricky poháněnému mechanismu. Přidržením tlačítka na rámu postele dojde ke zvednutí výklopné části boxu bez nutnosti použít mechanické síly. Plné využití úložného prostoru se tak stane snadným a pohodlným.



**Designová postel UP Metal** je určena pro ty, kteří potřebují více úložného prostoru v ložnici a také upřednostňují jednu společnou partnerskou matraci. Rám postele má 5 nebo 8 cm tloušťku, 30 nebo 35 cm výšku. Vybaven je speciálním roštem s kovovou konstrukcí, který se z přední části postele vyklápí pomocí kování s pneumatickými písty, které usnadňují přístup do úložného prostoru i při použití těžkých matrací. Kovový rám roštu je osazen předpjatými lamelami. Demontáží dna v úložném prostoru získáme přístup pod celou plochou postele, což oceníte především při úklidu.



**Konstrukčně stejná je i designová postel UP BV a UP NV**

(s polohováním hlavy), rozdíl je v použití dřevěných výklopných roštů. Pro tuto postel je vhodné použít dvě samostatné matrace, aby bylo možné plnohodnotně využívat výklopné rošty. Matrace při použití roštů METAL, DOBLE NV a DOUBLE BV je zapuštěna cca 6 cm od vrchní hrany bočnice. V provedení Corium lze rošt METAL namontovat ve výšce boční hrany bočnice a matrace je uložena i na roštu, i na bočnicích. Taková postel bude působit dojmem boxspringu a šířka postele (včetně bočnic) bude stejná s šířkou matrace. Designová postel (bez úložného prostoru) je určena pro ty, kteří nepotřebují úložný prostor v posteli. Rám postele je podobný jako u postelí s UP, neobsahuje však upevnění pro dno úložného prostoru. V tomto rámu je možné použít všechny typy roštů pod matraci: od jednoduchých masivních laťových roštů, přes laťové masivní v rámy, pružné lamelové, polohovatelné, až po modely s plynulým elektrickým polohováním. Korpusy vyrábíme ve dvou různých tloušťkách panelů: 5 nebo 8 cm a třech výškách: 15, 30 nebo 35 cm.



## SETY POSTELÍ, ČALOUNĚNÍ STĚN A DOPLŇKŮ

Novinka, která je velmi vítaná nejen ze strany interiérových designérů a hoteliérů, ale stále více i běžných spotřebitelů, je možnost si z naší nabídky ke každé posteli objednat i taburet, noční stolky, křeslo nebo podnožku ke křeslu ve stejné čalounické látce jako je látka postele. Pro ty, kteří již mají vlastní kvalitní postel (např. z masivu) a plánují povznést interiér své ložnice, nabízíme možnost kombinovat ve stejné čalounické látce jednotlivé interiérové doplňky navzájem nebo spolu s některým z variant pro čalounění stěny za čelem postele. SET (kombinace) postele a některého nebo všech ze zmíněných interiérových doplňků v identické čalounické látce umocňuje celkový dojem z Vaší ložnice, navozuje žádaný konečný pocit elegance a luxusu a je odrazem Vašeho jedinečného vkusu a preferencí.





# DAMIANI SET

NEW

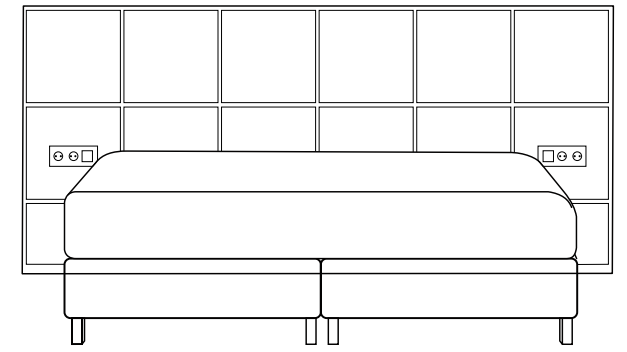

DAMIANI  
(p. 27)

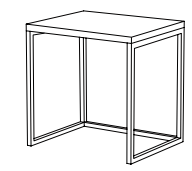
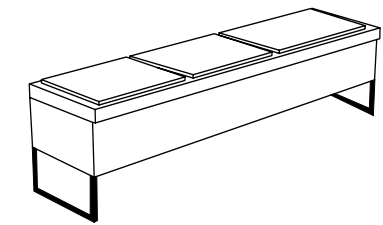



# CRISTAL SET

NEW

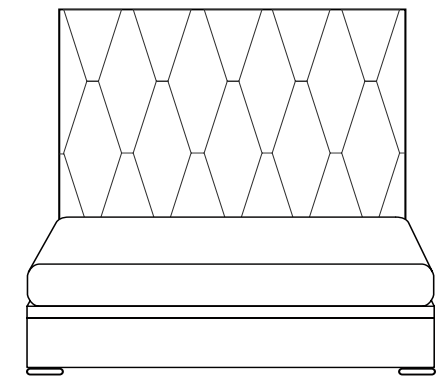

**CRISTAL**  
(p. 23)

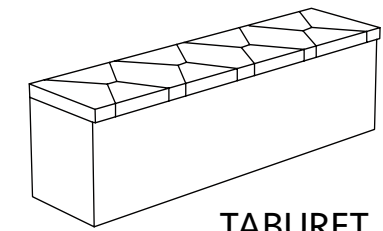

**TABURET**  
No. 5 (p. 102)

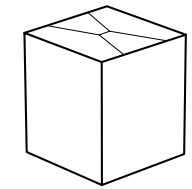



# SPECTRA SET

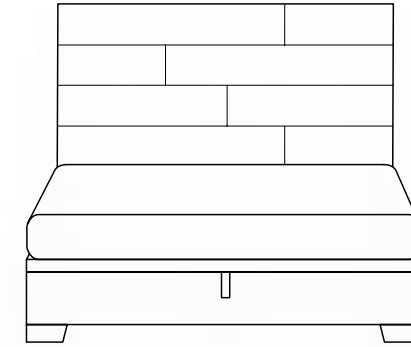

**SPECTRA**  
(p. 46)

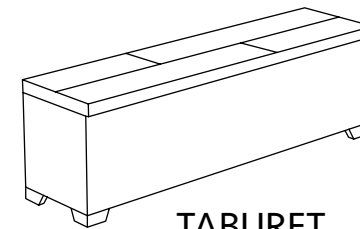

**TABURET**  
No. 7 (p. 102)



**BIANCA**  
(p. 101)

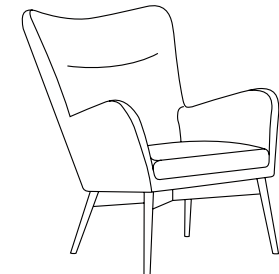

**BREEZE**  
(p. 95)

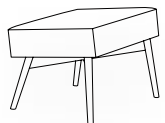

**CUT**  
(p. 98)





# CORONA SET

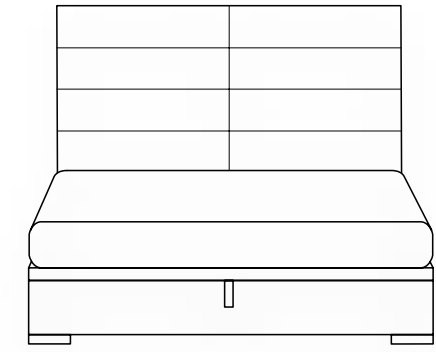

**CORONA**  
(p. 68)

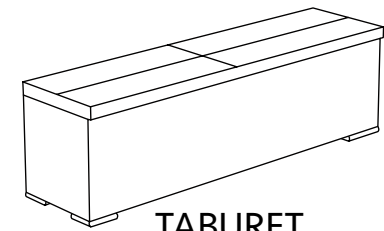

**TABURET**  
No. 4 (p. 102)

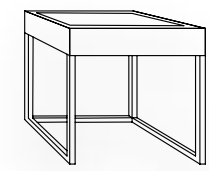

**INDUSTRY**  
(p. 99)

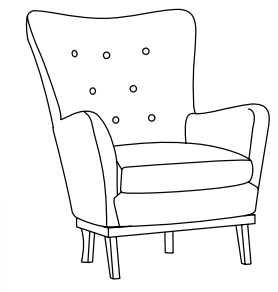

**DE LUXE**  
(p. 96)

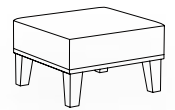

**CASTELO**  
(p. 98)



# FRANCESCA LUX SET

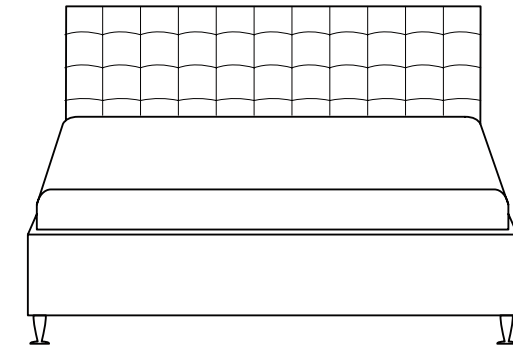

**FRANCESCA LUX**  
(p. 57)

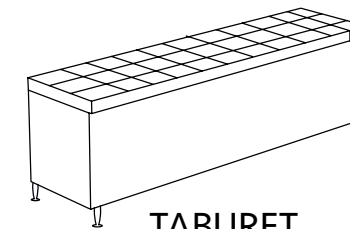

**TABURET**  
No. 12 (p. 102)

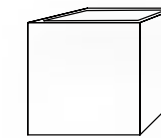

**CUBE**  
(p. 101)

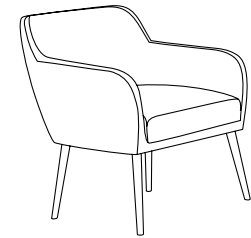

**MODERN**  
(p. 97)



**CROSS**  
(p. 98)



# SOUL SET

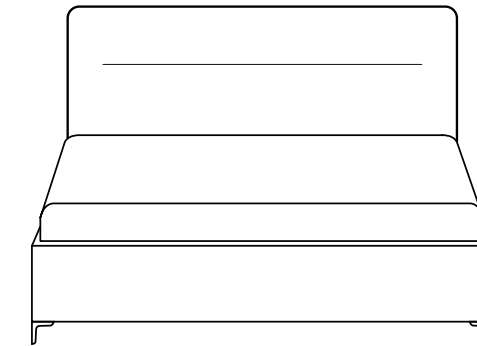

**SOUL**  
(p. 29)

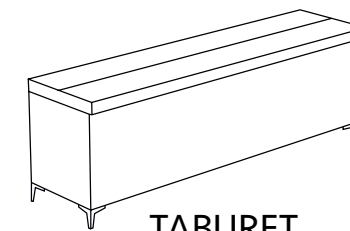

**TABURET**  
No. 1; 3 (p. 102)

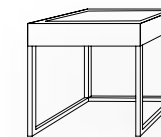

**INDUSTRY**  
(p. 99)

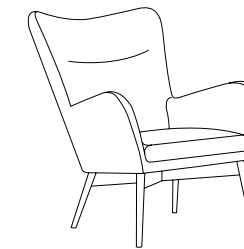

**BREEZE MIRACH**  
(p. 95)



**CROSS**  
(p. 98)



# CRISTAL

NEW

	L	b <sup>L</sup>	b <sup>W</sup>	b <sup>H</sup>	h <sup>W</sup>	h <sup>H</sup>	m <sup>L</sup>	m <sup>W</sup> (cm)
<b>Maxi Elektro 32</b>	208	200	180	32	180	160	200	180

Taburet  
(p. 102)

No. 5

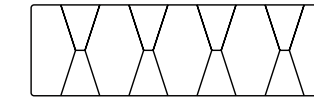

No. 1

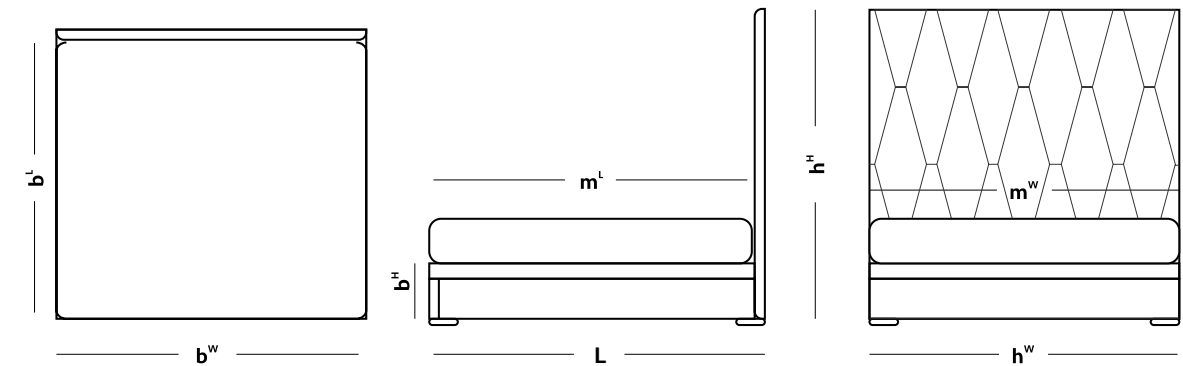



# LA SPEZIA

NEW

	L	b <sup>L</sup>	b <sup>W</sup>	b <sup>H</sup>	h <sup>W</sup>	h <sup>H</sup>	m <sup>L</sup>	m <sup>W</sup> (cm)
<b>DESINGBED</b>	213	203	186	35	246	125+3	200	180

**Taburet  
(p. 102)**

**No. 2**

**No. 1**

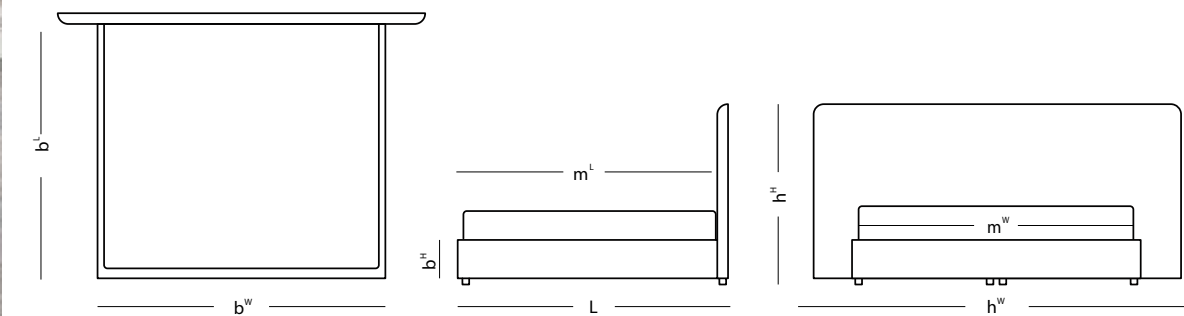
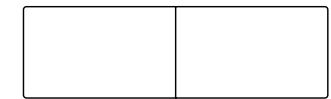

BODY & DIMENSIONS



Width 74.0



Fuel Tank Capacity 17 gal  
MPG Up to 18 city / 18 hwy

Front 265 35 ZR 20  
Rear 305 30 ZR 21



# DAMIANI

NEW

	L	b <sup>L</sup>	b <sup>w</sup>	b <sup>H</sup>	h <sup>w</sup>	h <sup>H</sup>	m <sup>L</sup>	m <sup>w</sup>	(cm)
<b>BOXSPRING22</b>	207	200	180	22	272	122	200	180	

Taburet

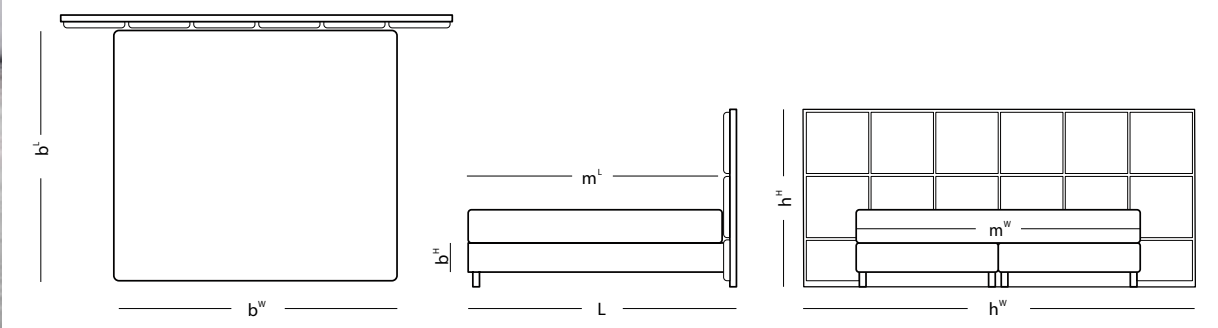
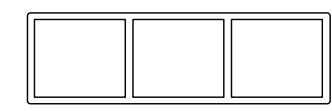



# SOUL

NEW

	L	b <sup>L</sup>	b <sup>W</sup>	b <sup>H</sup>	b <sup>D</sup>	h <sup>W</sup>	h <sup>H</sup>	m <sup>L</sup>	m <sup>W</sup> (cm)
<b>DESINGBED</b>	216	205	190	35	5	196	120	200	180
<b>v prevedení CORIUM</b>	211	200	180	35	5	186	120	200	180

Taburet  
(p. 102)

No. 1

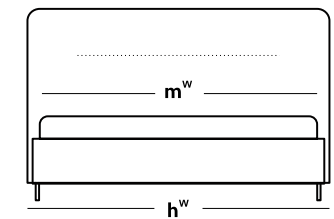
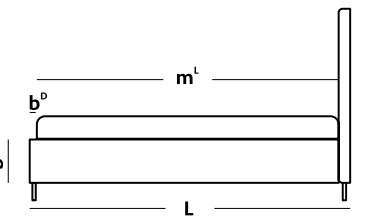
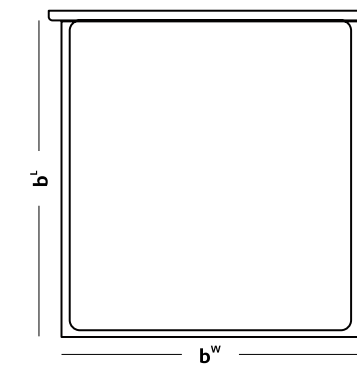



# CORIUM

	L	b <sup>L</sup>	b <sup>W</sup>	b <sup>H</sup>	h <sup>W</sup>	h <sup>H</sup>	m <sup>L</sup>	m <sup>W</sup> (cm)
<b>DESINGBED</b>	209	200	180	30	180	150	200	180
<b>v prevedení CORIUM</b>	209	200	160	30	160	150	200	160

Taburet  
(p. 102)

No. 6

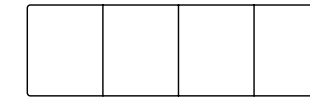

No. 1

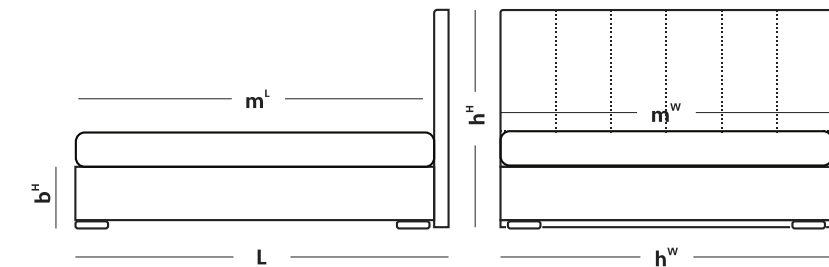
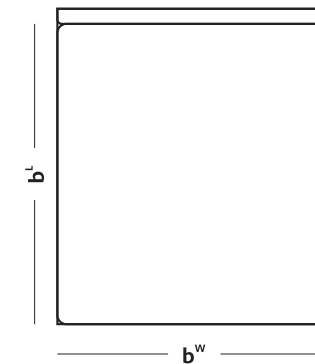





# FOREST

	L	b <sup>L</sup>	b <sup>W</sup>	b <sup>H</sup>	h <sup>W</sup>	h <sup>H</sup>	m <sup>L</sup>	m <sup>W</sup> (cm)
<b>Boxspring 32</b>	208	200	180	32	180	160	200	180
	208	200	160	32	160	160	200	160

**Taburet**  
(p. 102)

**No. 1**



**No. 18**

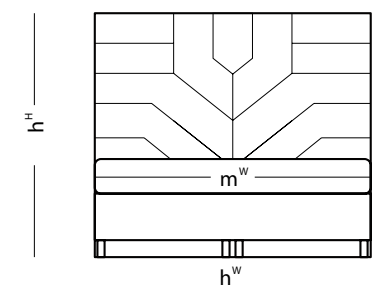
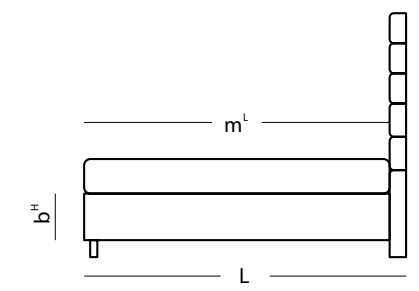
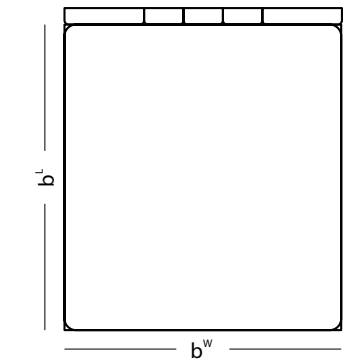
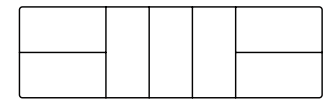



# CHESTERFIELD

	L	b <sup>L</sup>	b <sup>W</sup>	b <sup>H</sup>	h <sup>W</sup>	h <sup>H</sup>	m <sup>L</sup>	m <sup>W</sup> (cm)
<b>Boxspring 22</b>	213	200	180	22	180	143	200	180
	213	200	160	22	160	143	200	160

**Taburet  
(p. 102)**

**No. 1**



**No. 17**

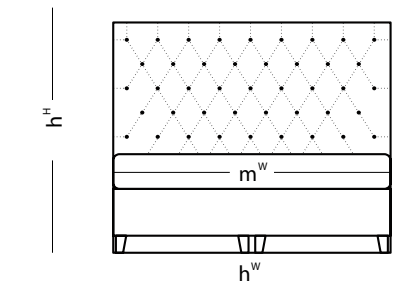
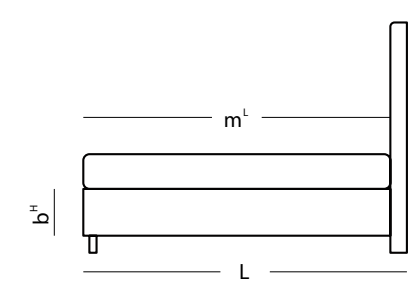
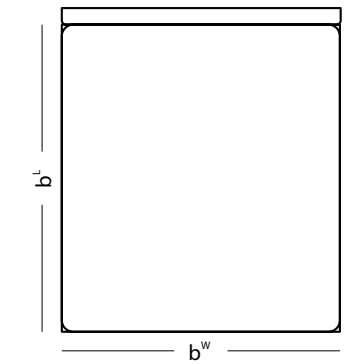
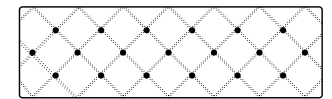



# RHOMBUS

	L	b <sup>L</sup>	b <sup>W</sup>	b <sup>H</sup>	h <sup>W</sup>	h <sup>H</sup>	m <sup>L</sup>	m <sup>W</sup> (cm)
<b>Boxspring 32</b>	208	200	180	32	180	160	200	180
	208	200	160	32	160	160	200	160

Taburet  
(p. 102)

No. 11

No. 1

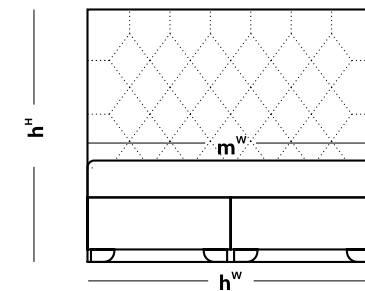
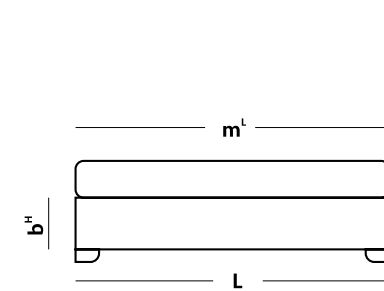
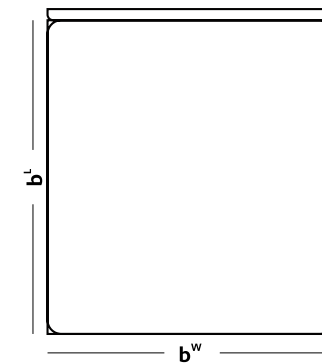
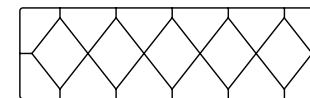



# WILD

	L	b <sup>L</sup>	b <sup>W</sup>	b <sup>H</sup>	h <sup>W</sup>	h <sup>H</sup>	m <sup>L</sup>	m <sup>W</sup> (cm)
<b>Boxspring 32</b>	208	200	180	32	180	160	200	180
	208	200	160	32	160	160	200	160

**Taburet  
(p. 102)**

**No. 16**

**No. 1**

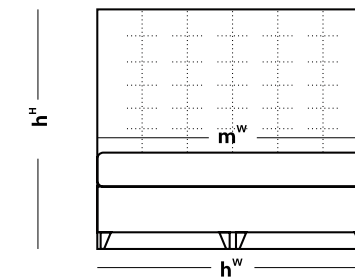
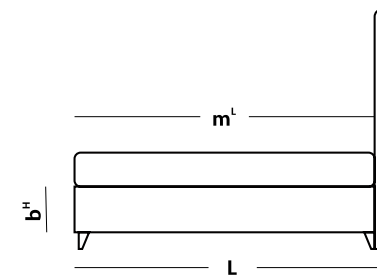
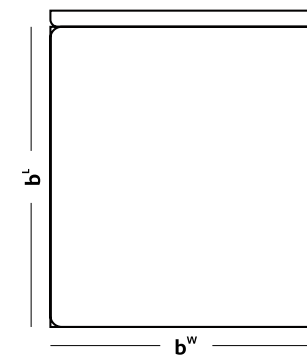
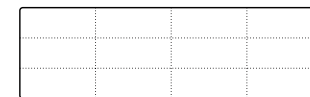



# KINGSTONE

	L	b <sup>L</sup>	b <sup>W</sup>	b <sup>H</sup>	b <sup>D</sup>	h <sup>W</sup>	h <sup>H</sup>	m <sup>L</sup>	m <sup>W</sup> (cm)
<b>Design Bed</b>	218	205	190	35	5	190	120	200	180
	218	205	170	35	5	170	120	200	160

**Taburet  
(p. 102)**

**No. 2**

**No. 1**

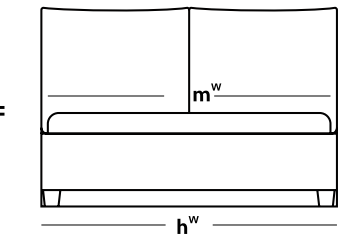
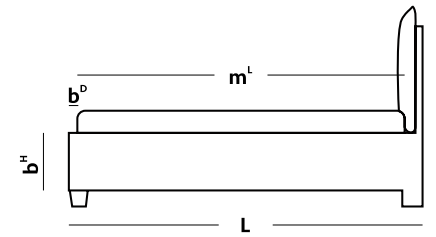
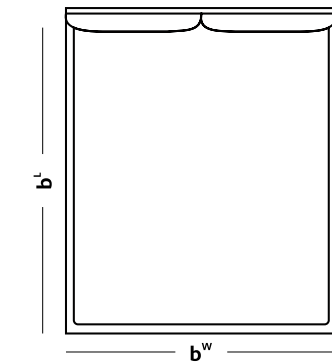
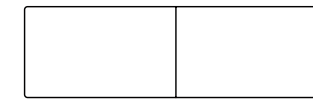



# HONEY

	L	b <sup>L</sup>	b <sup>W</sup>	b <sup>H</sup>	b <sup>D</sup>	h <sup>W</sup>	h <sup>H</sup>	m <sup>L</sup>	m <sup>W</sup> (cm)
<b>Design Bed</b>	213	205	190	35	5	190	120	200	180
	213	205	170	35	5	170	120	200	160

**Taburet  
(p. 102)**

**No. 8**

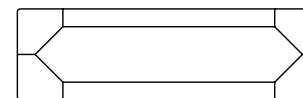

**No. 1**

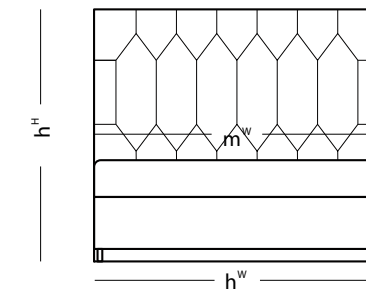
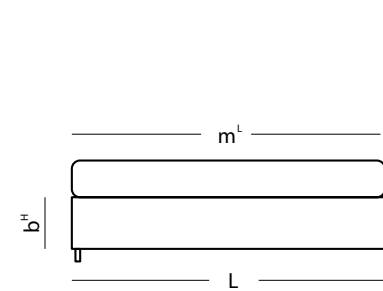
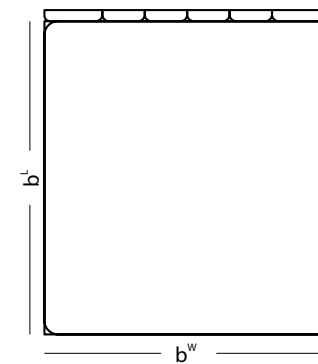

# MELVA

	L	b <sup>L</sup>	b <sup>W</sup>	b <sup>H</sup>	h <sup>W</sup>	h <sup>H</sup>	m <sup>L</sup>	m <sup>W</sup> (cm)
<b>Boxspring 32</b>	208	200	180	32	186	160	200	180
	208	200	160	32	166	160	200	160

Taburet  
(p. 102)

No. 13

No. 1

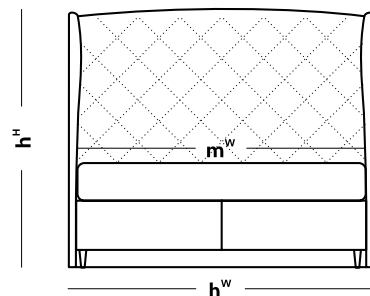
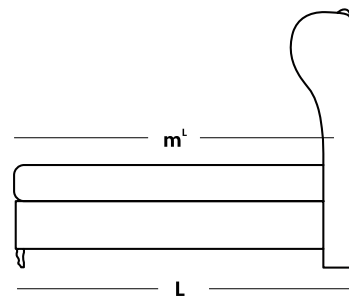
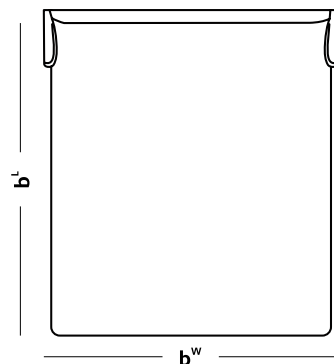
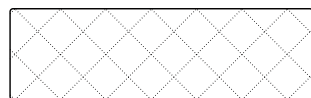

# SPECTRA

	L	b <sup>L</sup>	b <sup>W</sup>	b <sup>H</sup>	h <sup>W</sup>	h <sup>H</sup>	m <sup>L</sup>	m <sup>W</sup> (cm)
MAXI	208	200	180	32	180	130	200	180
	208	200	160	32	160	130	200	160

Taburet  
(p. 102)

No. 7

No. 1

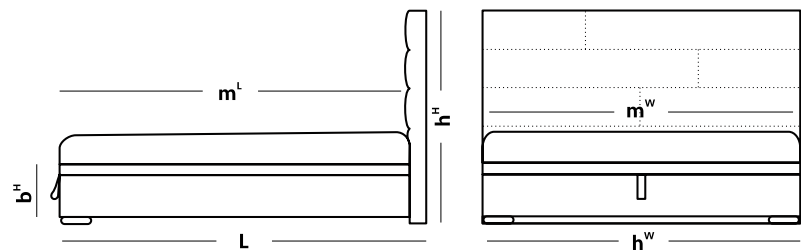
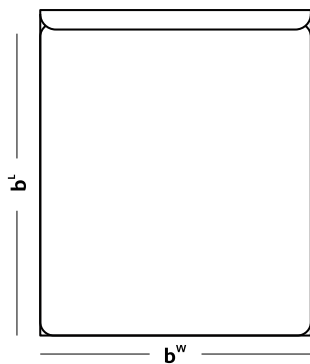
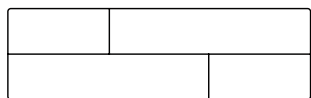



# HORIZONTAL

	L	b <sup>L</sup>	b <sup>W</sup>	b <sup>H</sup>	h <sup>W1</sup>	h <sup>W2</sup>	h <sup>H</sup>	m <sup>L</sup>	m <sup>W</sup> (cm)
<b>MAXI</b>	210	200	180	32	180	240	145	200	180
	210	200	160	32	160	220	145	200	160

Taburet  
(p. 102)

No. 3

No. 1

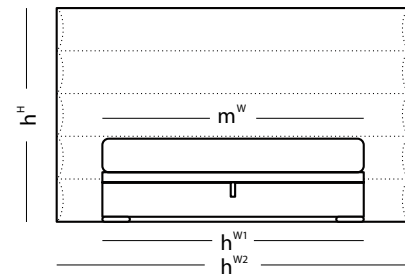
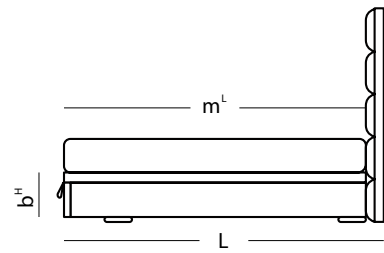
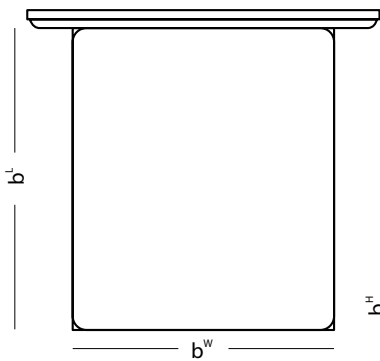
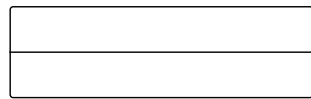

# NAVY

	L	b <sup>L</sup>	b <sup>W</sup>	b <sup>H</sup>	b <sup>D</sup>	h <sup>W</sup>	h <sup>H</sup>	m <sup>L</sup>	m <sup>W</sup> (cm)
<b>Design Bed</b>	213	205	190	30	5	190	123	200	180
	213	205	170	30	5	170	123	200	160

Taburet  
(p. 102)

No. 1

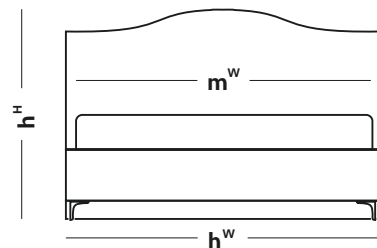
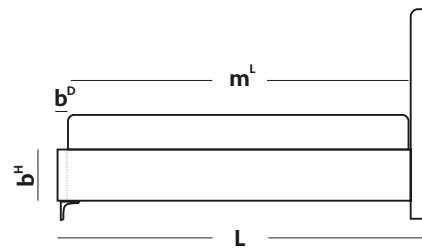
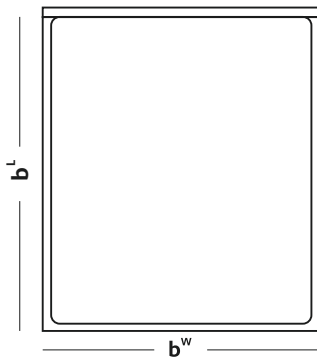

# ENIF

	L	b <sup>L</sup>	b <sup>W</sup>	b <sup>H</sup>	b <sup>P</sup>	h <sup>W</sup>	h <sup>H</sup>	m <sup>L</sup>	m <sup>W</sup> (cm)
Design Bed	213	205	190	35	5	196	123	200	180
	213	205	170	35	5	176	123	200	160

Taburet  
(p. 102)

No. 1

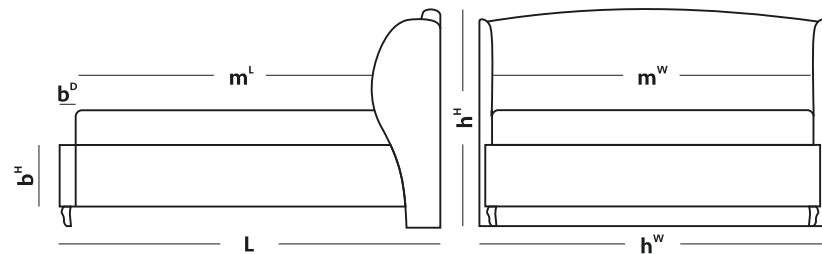
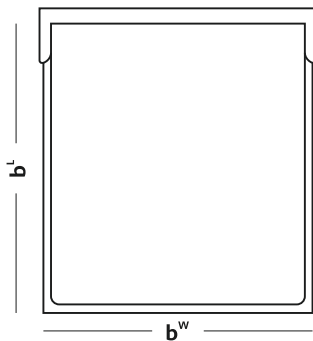

# GEMINI

	L	b <sup>L</sup>	b <sup>W</sup>	b <sup>H</sup>	b <sup>P</sup>	h <sup>W</sup>	h <sup>H</sup>	m <sup>L</sup>	m <sup>W</sup> (cm)
<b>Design Bed</b>	213	205	190	30	5	190	150	200	180
	213	205	170	30	5	170	150	200	160

Taburet  
(p. 102)

No. 6

No. 1

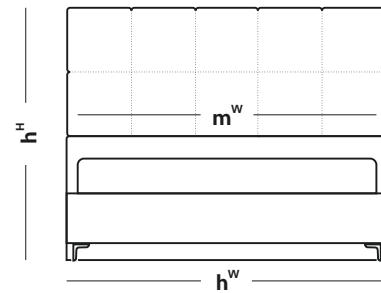
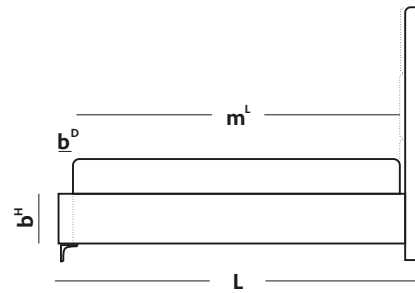
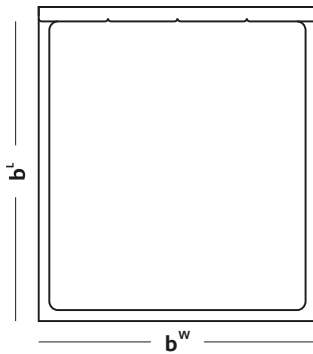
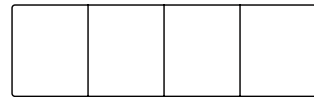



# FRANCESCA LUX

	L1   L2	b <sup>L</sup>	b <sup>W</sup>	b <sup>H</sup>	b <sup>D</sup>	h <sup>W</sup>	h <sup>H</sup>	m <sup>L</sup>	m <sup>W</sup> (cm)
<b>Design Bed</b>	231   216	205	190	30	5	190	103	200	180
	231   216	205	170	30	5	170	103	200	160

**Taburet**  
(p. 102)

**No. 12**

**No. 1**

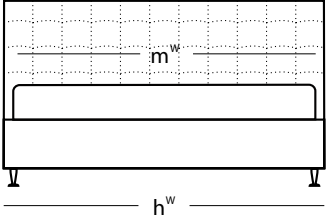
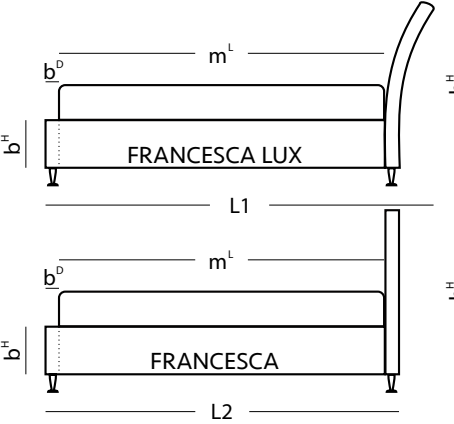
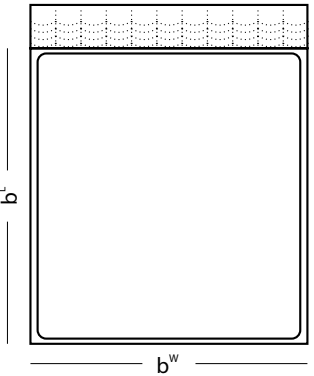
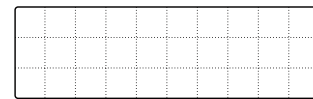



# CLAUDIA LUX

	L1   L2	b <sup>L</sup>	b <sup>W</sup>	b <sup>H</sup>	b <sup>D</sup>	h <sup>W</sup>	h <sup>H</sup>	m <sup>L</sup>	m <sup>W</sup> (cm)
<b>Design Bed</b>	234   219	208	196	30	8	196	103	200	180
	234   219	208	176	30	8	176	103	200	160

**Taburet  
(p. 102)**

**No. 16**

**No. 1**

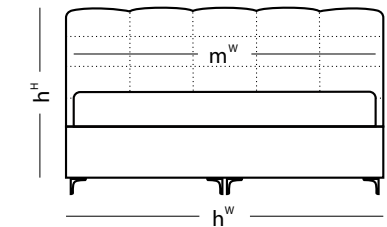
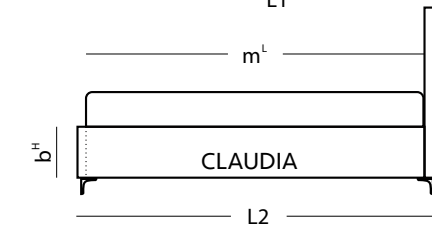
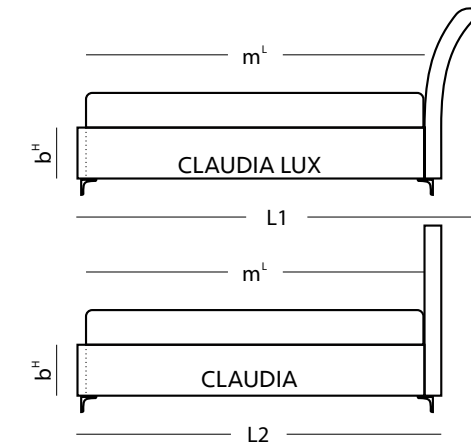
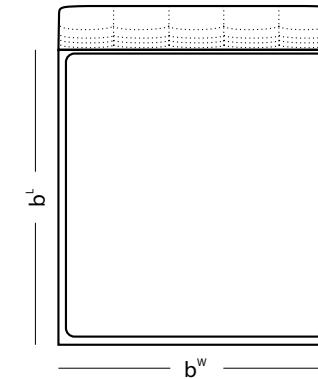
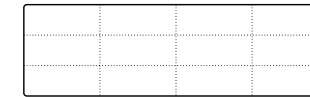

# ALESIA

	L	b <sup>L</sup>	b <sup>W</sup>	b <sup>H</sup>	b <sup>D</sup>	h <sup>W</sup>	h <sup>H</sup>	m <sup>L</sup>	m <sup>W</sup> (cm)
<b>Design Bed</b>	217	205	190	30	5	190	103	200	180
	217	205	170	30	5	170	103	200	160

Taburet  
(p. 102)

No. 13

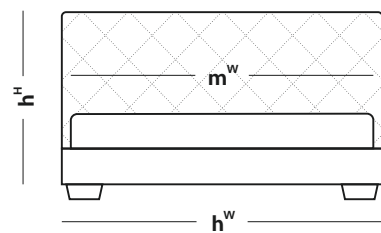
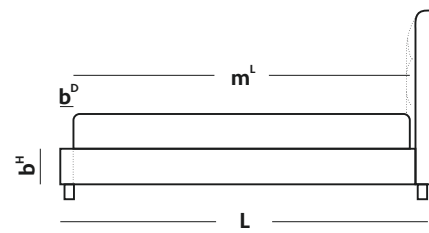
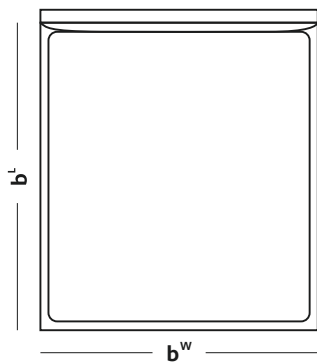



# VEGA

	L	b <sup>L</sup>	b <sup>W</sup>	b <sup>H</sup>	b <sup>D</sup>	h <sup>W</sup>	h <sup>H</sup>	m <sup>L</sup>	m <sup>W</sup> (cm)
<b>Design Bed</b>	213	205	190	30	5	190	130	200	180
	213	205	170	30	5	170	130	200	160

**Taburet  
(p. 102)**

**No. 6**

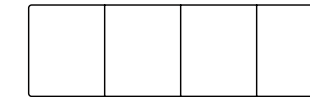

**No. 1**

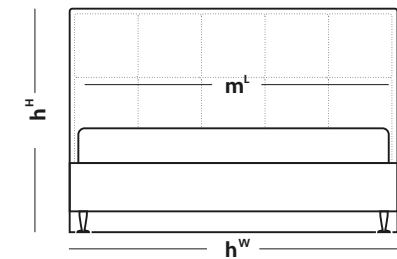
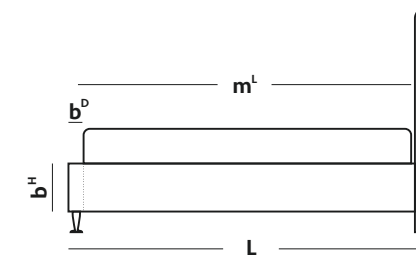
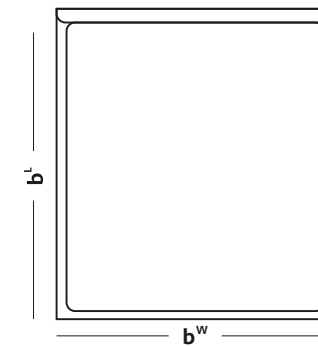





# BELLATRIX

	L	b <sup>L</sup>	b <sup>W</sup>	b <sup>H</sup>	b <sup>D</sup>	h <sup>W</sup>	h <sup>H</sup>	m <sup>L</sup>	m <sup>W</sup> (cm)
<b>Design Bed</b>	213	205	190	35	5	190	120	200	180
	213	205	170	35	5	170	120	200	160

**Taburet  
(p. 102)**

**No. 10**

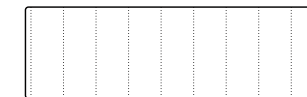

**No. 1**

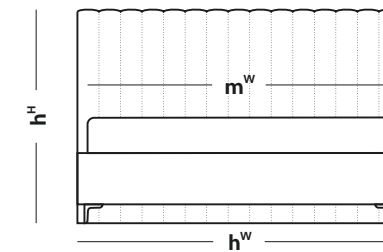
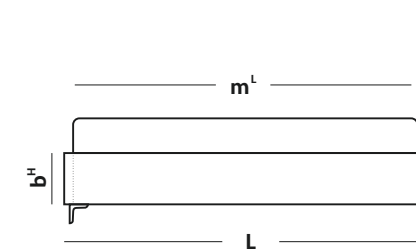
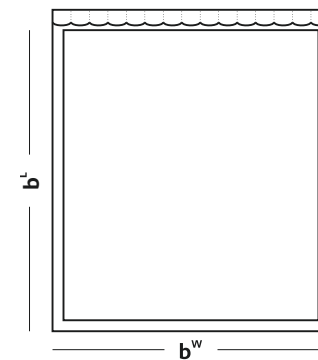

# ATLAS

	L	b <sup>L</sup>	b <sup>W</sup>	b <sup>H</sup>	h <sup>W</sup>	h <sup>H</sup>	m <sup>L</sup>	m <sup>W</sup> (cm)
<b>Boxspring 22</b>	225	200	180	22	180	100	200	180
	225	200	160	22	160	100	200	160

Taburet  
(p. 102)

No. 8



No. 1

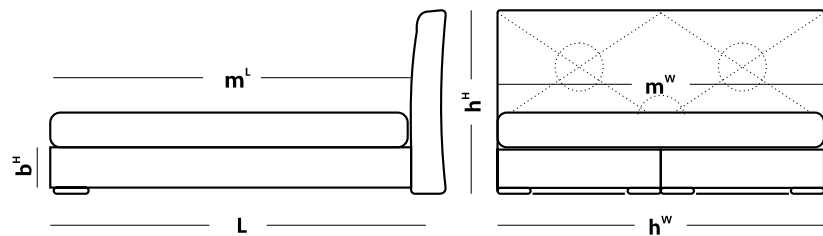
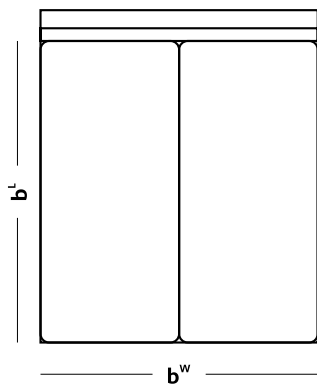

# CORONA

	L	b <sup>L</sup>	b <sup>W</sup>	b <sup>H</sup>	h <sup>W</sup>	h <sup>H</sup>	m <sup>L</sup>	m <sup>W</sup> (cm)
MAXI	208	200	180	32	180	120	200	180
	208	200	160	32	160	120	200	160

Taburet  
(p. 102)

No. 4

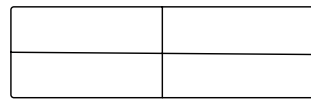

No. 1

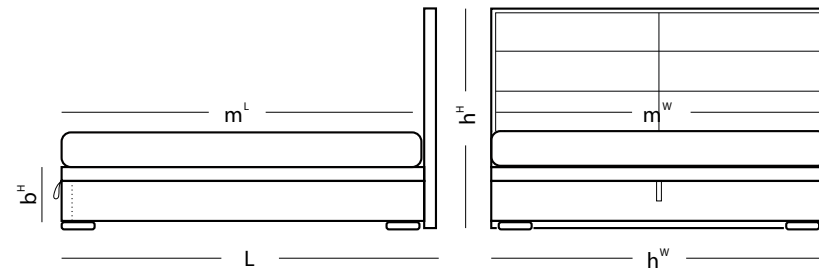
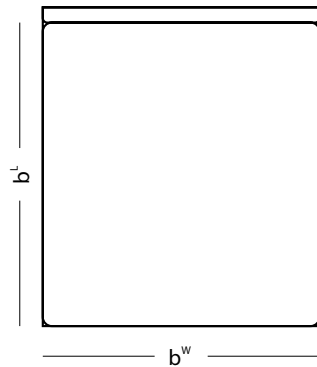

# PARIS

	L	b <sup>L</sup>	b <sup>W</sup>	b <sup>H</sup>	h <sup>W</sup>	h <sup>H</sup>	m <sup>L</sup>	m <sup>W</sup> (cm)
Boxspring 32 + Cover	208	200	180	32	180	197	200	180
	208	200	160	32	160	197	200	160

Taburet  
(p. 102)

No. 6

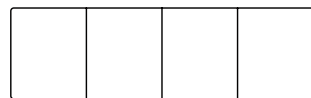

No. 1

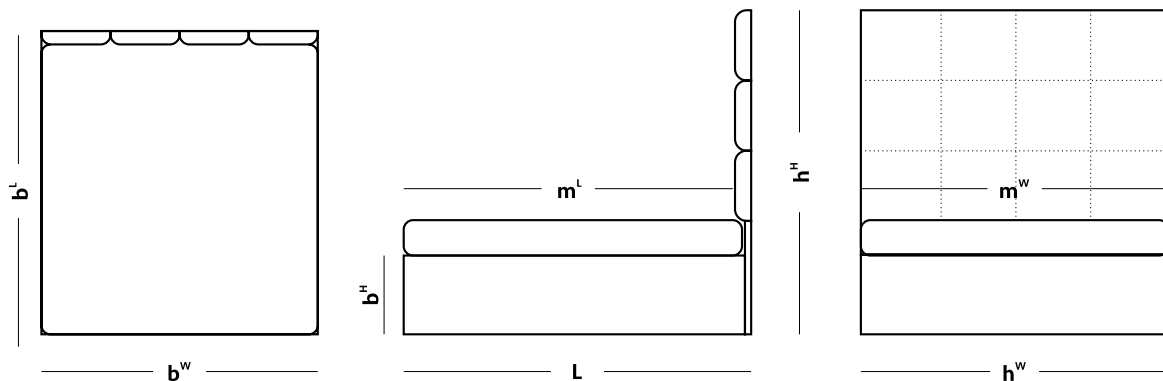

70



# VIENNA

	L	b <sup>L</sup>	b <sup>W</sup>	b <sup>H</sup>	h <sup>W</sup>	h <sup>H</sup>	m <sup>L</sup>	m <sup>W</sup> (cm)
<b>Boxspring 32</b>	208	200	180	32	190	160	200	180
	208	200	160	32	170	160	200	160

Taburet  
(p. 102)

No. 15

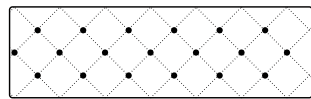

No. 1

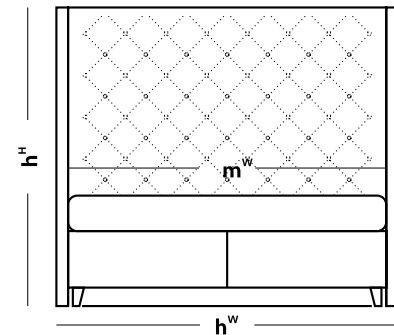
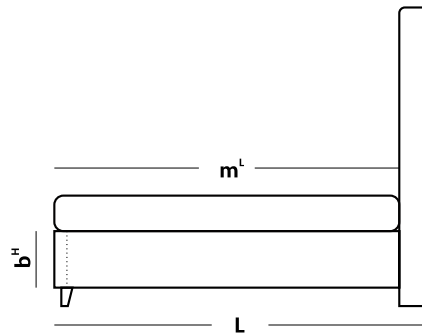
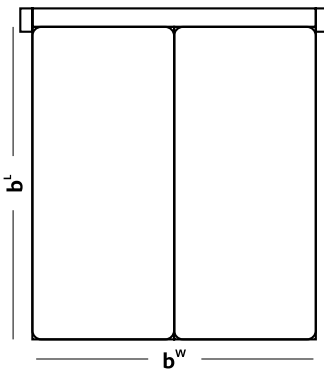

# NOBILIA

	L	b <sup>L</sup>	b <sup>W</sup>	b <sup>H</sup>	b <sup>D</sup>	h <sup>W</sup>	h <sup>H</sup>	m <sup>L</sup>	m <sup>W</sup> (cm)
<b>Design Bed</b>	213	205	190	30	5	190	120	200	180
	213	205	170	30	5	170	120	200	160

Taburet  
(p. 102)

No. 9

No. 1

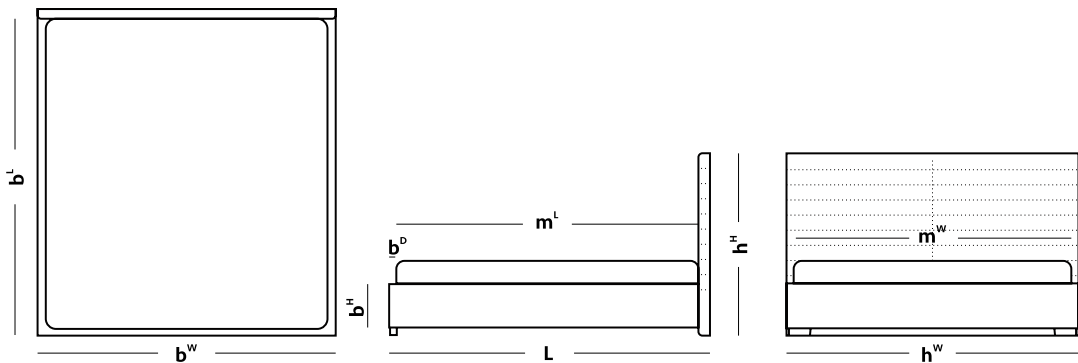



# ARGENTINA

	L	b <sup>L</sup>	b <sup>W</sup>	b <sup>H</sup>	b <sup>D</sup>	h <sup>W</sup>	h <sup>H</sup>	m <sup>L</sup>	m <sup>W</sup> (cm)
<b>Design Bed</b>	213	205	190	35	5	190	120	200	180
	213	205	170	35	5	170	120	200	160

**Taburet  
(p. 102)**

**No. 1**

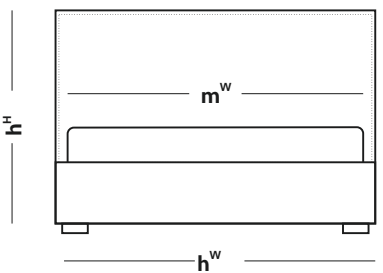
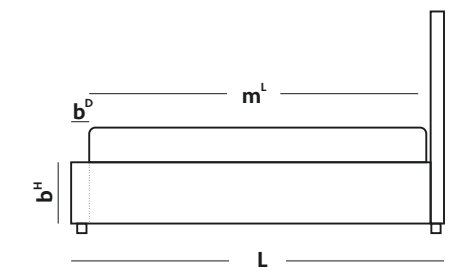
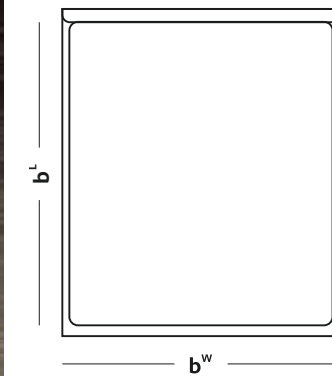



# SIRIUS

	L	b <sup>l</sup>	b <sup>w</sup>	b <sup>h</sup>	h <sup>w</sup>	h <sup>h</sup>	m <sup>l</sup>	m <sup>w</sup> (cm)
<b>Boxspring mobil</b>	208	200	180	32	180	120	200	180
	208	200	160	32	160	120	200	160

**Taburet  
(p. 102)**

**No. 1**

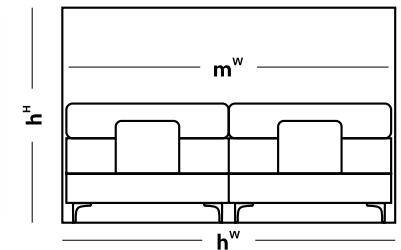
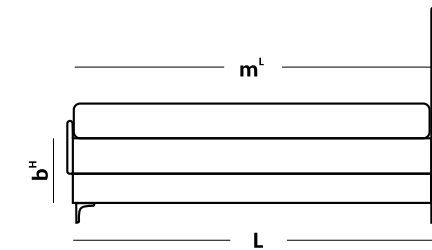
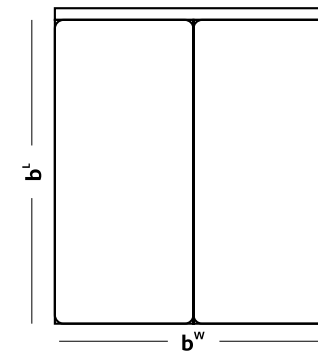





# VELORUM

	L	b <sup>L</sup>	b <sup>W</sup>	b <sup>H</sup>	h <sup>W</sup>	h <sup>H</sup>	m <sup>L</sup>	m <sup>W</sup> (cm)
<b>Boxspring 32</b>	208	200	180	32	180	120	200	180
	208	200	160	32	160	120	200	160

**Taburet  
(p. 102)**

**No. 14**

**No. 1**

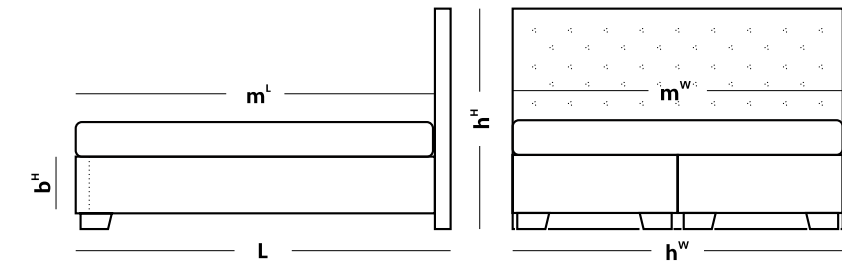
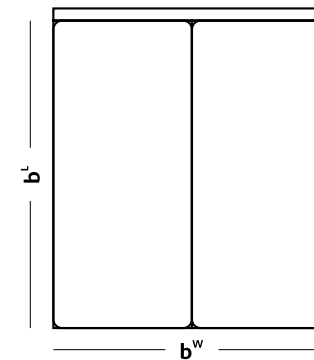
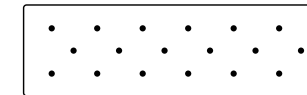



# WALL

NEW

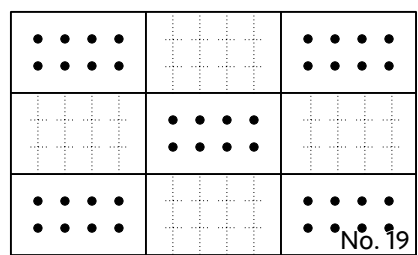
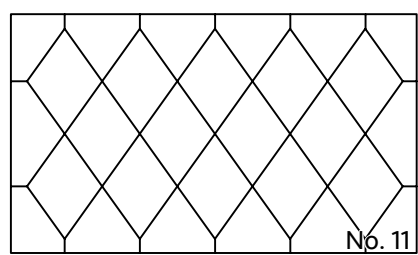
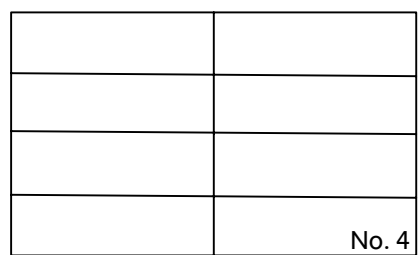
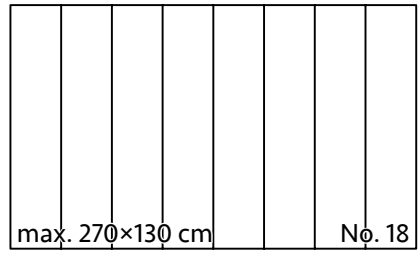
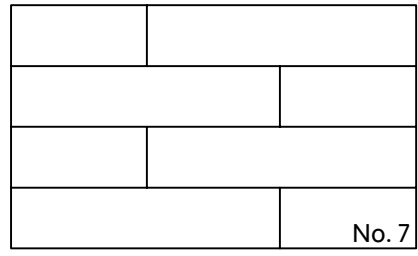
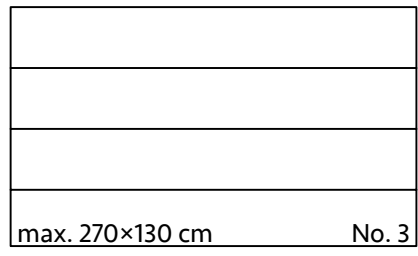
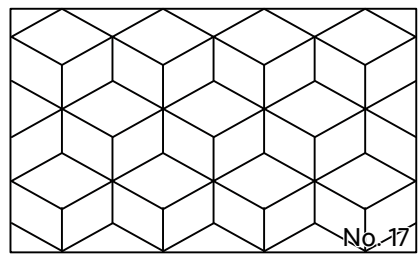
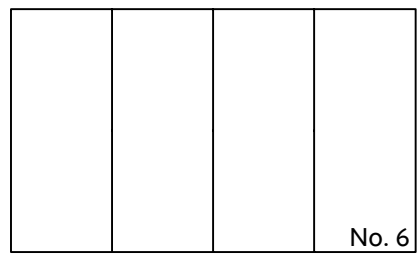
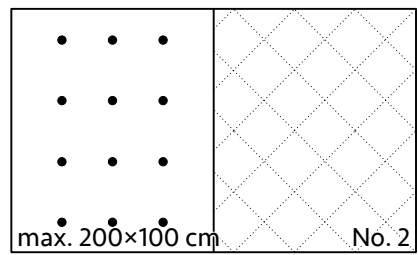



# TWINS

NEW

L	b <sup>w</sup>	b <sup>H</sup>	b <sup>H1</sup>	b <sup>H2</sup>	m <sup>L</sup>	m <sup>w</sup> (cm)
224	100	197	30	154	200	90

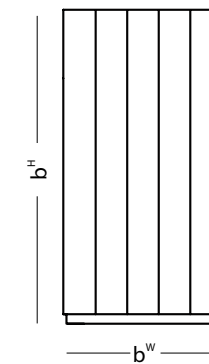
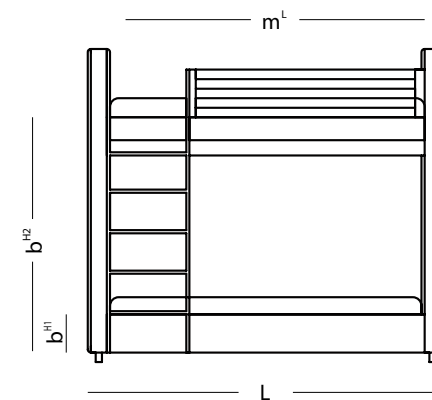
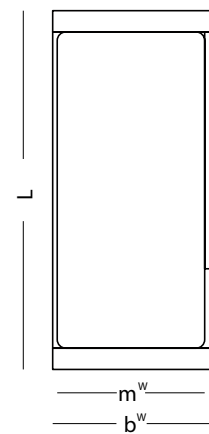



# SOFABED DOUBLE

	<b>a</b>	<b>b</b>	<b>c</b>	<b>d</b>	<b>f</b>	<b>g</b>	<b>h</b>	<b>m<sup>L</sup></b>	<b>m<sup>w</sup></b>	<b>L</b> (cm)
<b>Sofabed double</b>	163	98	48	60	13   17   21	55	85	190	140	215
<b>Sofabed triple</b>	183	98	48	60	13   17   21	55	85	190	160	215

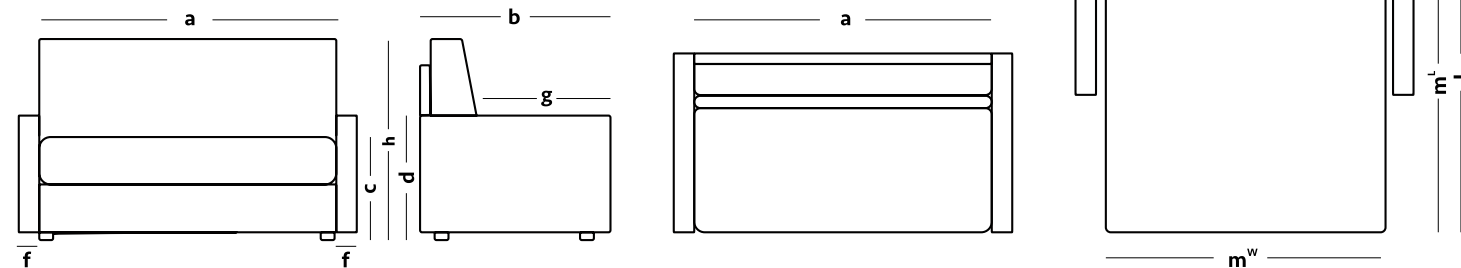



# SOFABED SINGLE

a	b	c	d	e	f	g	h	m <sup>L</sup>	m <sup>w</sup>	L (cm)
80	98	48	60	90	13   17   21	55	85	190	80	215

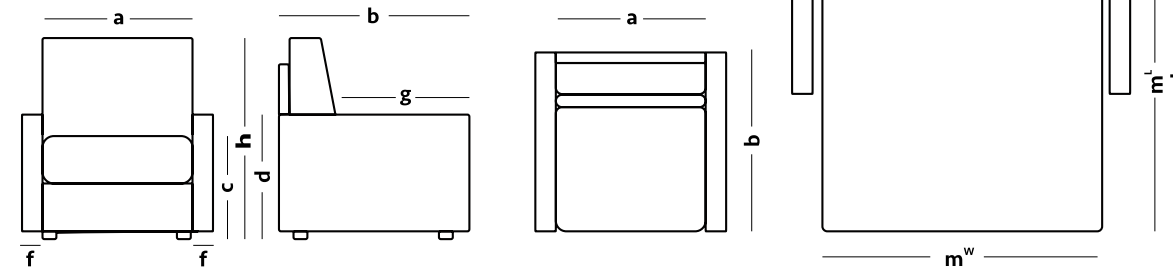

# boudoir MONT BLANC

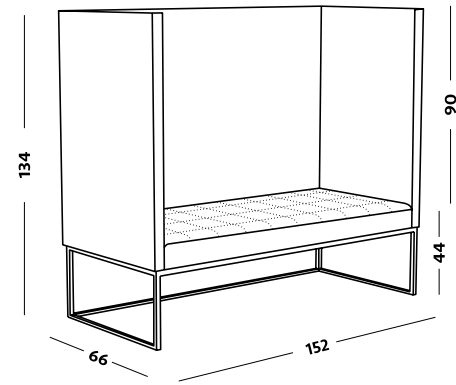

# MONT BLANC

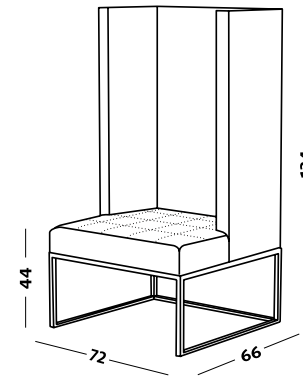

NEW

# BOSS



a	b	c	d	e	f	g	h	i	(cm)
50	50	105	95	50	50	78	95	30	

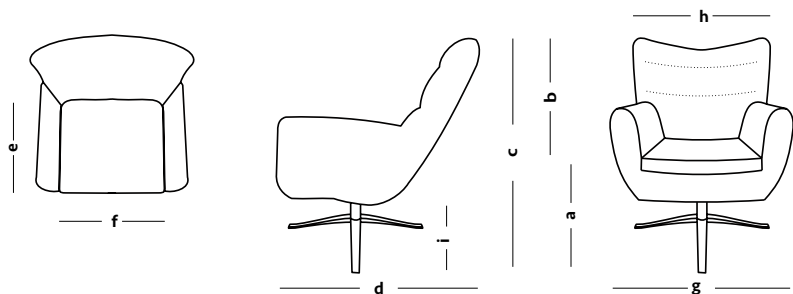

# MOON



a	b	c	d	(cm)
93	90	45	63	

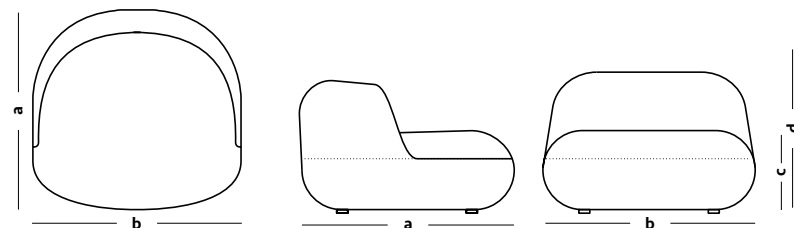

NEW



# boudoir BREEZE

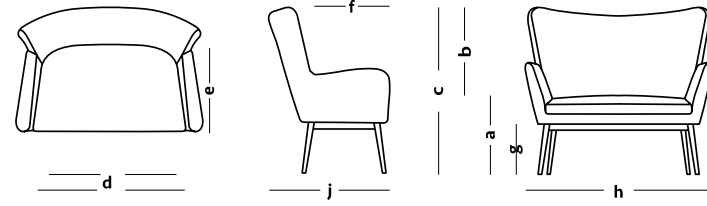

	a	b	c	d	e	f	g	h	j	(cm)
Cross	45	53	98	116/100	56	54	31	140	84	

# BREEZE

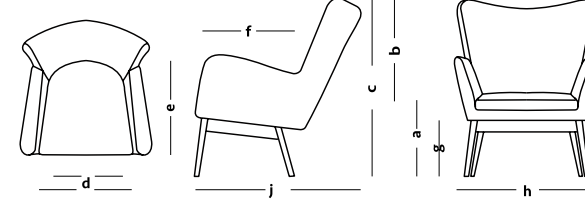

	a	b	c	d	e	f	g	h	j	(cm)
Cut	45	63	94	56/42	56	42	26/31	78	85	
Cross	45	63	102	56/42	56	42	32	78	80	

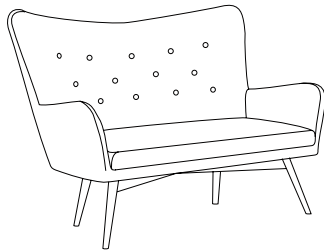

Button

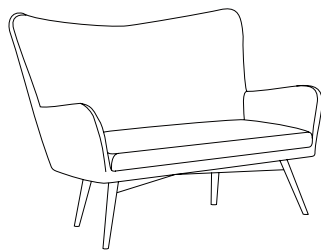

Clean

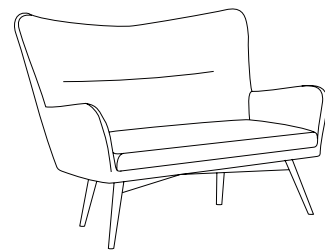

Mirach

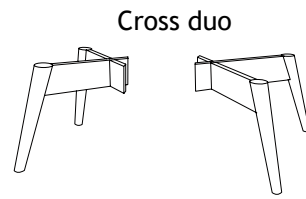

Cross duo

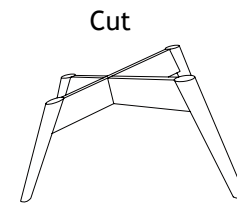

Cut

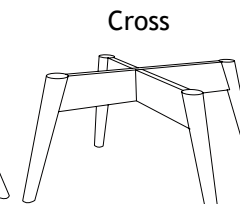

Cross

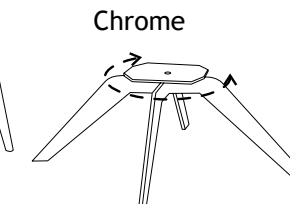

Chrome

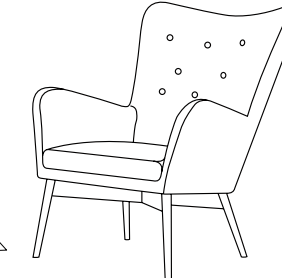

Button

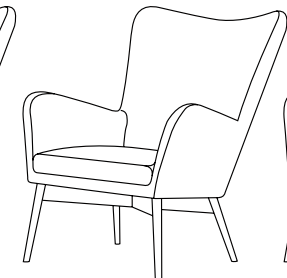

Clean

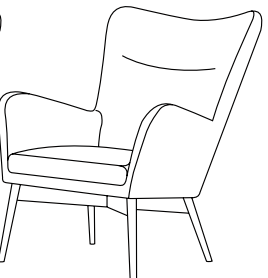

Mirach





# DE LUXE

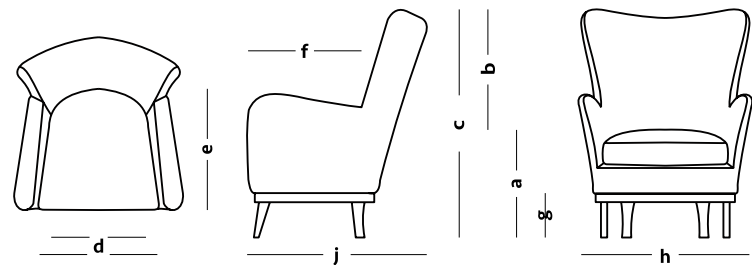

	a	b	c	d	e	f	g	h	j	(cm)
Castel	45	55	100	56/42	54	49	20	79	80	
Line	46	55	101	56/42	54	49	21	79	80	

# MODERN

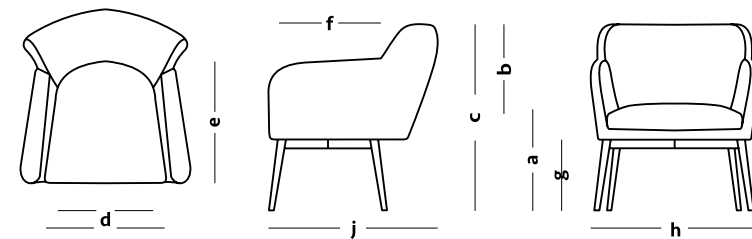

	a	b	c	d	e	f	g	h	j	(cm)
Cut	45	33	69	55/44	56	42	26/31	75	79	
Cross	45	33	78	55/44	56	42	32	75	75	

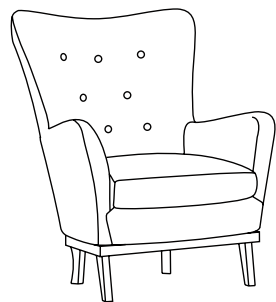

Button

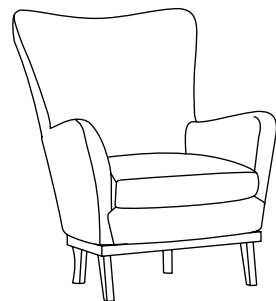

Clean

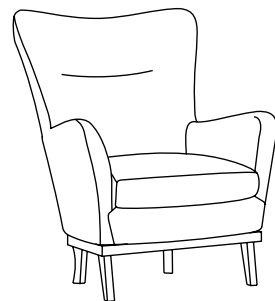

Mirach

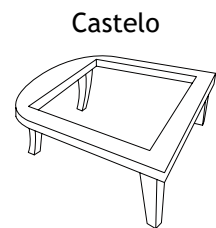

Castelo

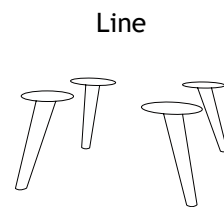

Line

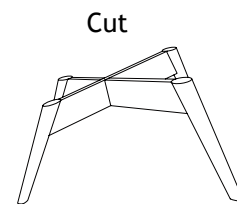

Cut

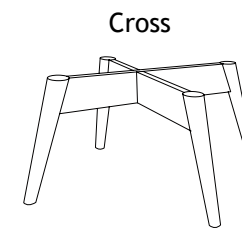

Cross

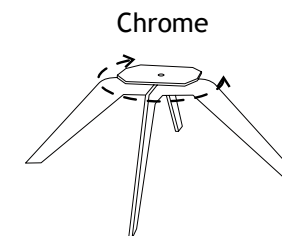

Chrome

# CUT

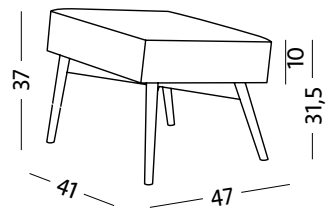

# CASTELO

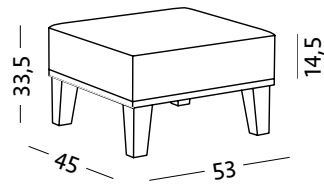

# CROSS

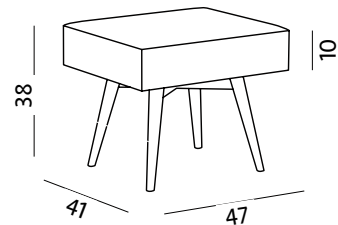

# INDUSTRY

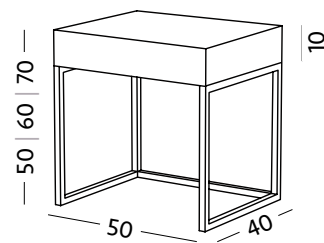

# HEAVY OAK

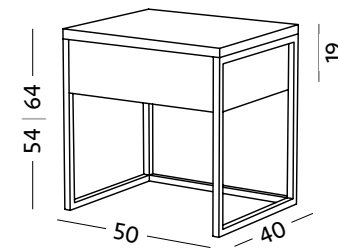

# OAK NEW

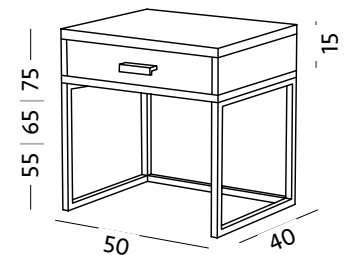

WHITE

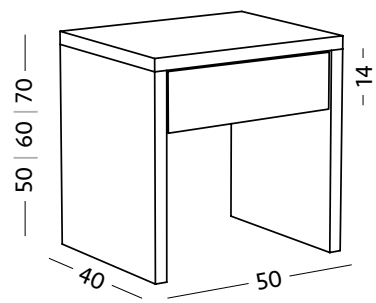

STONE

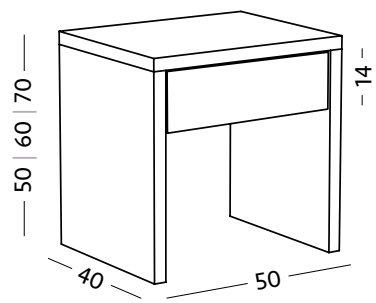

DARK STONE

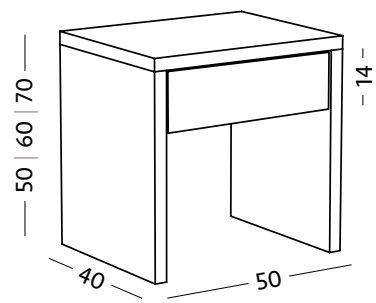

CUBE

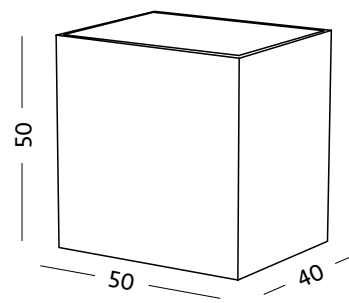

BIANCA

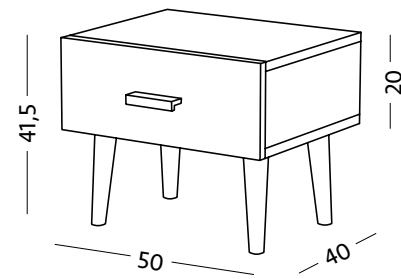

# TABURET | BENCH

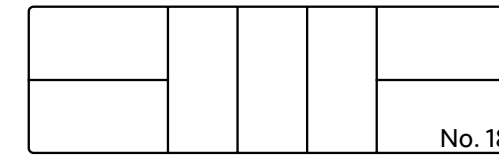
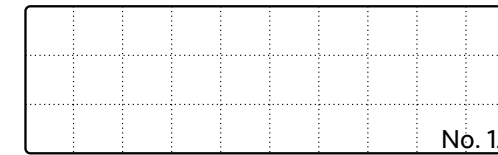
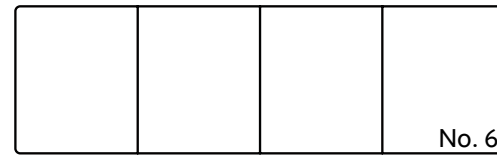
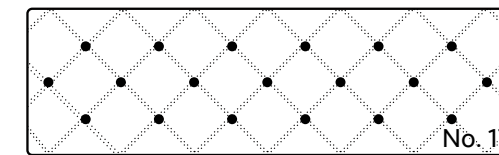
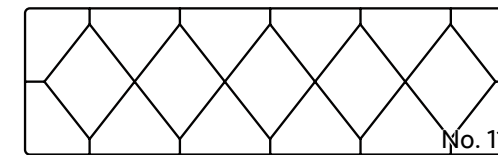
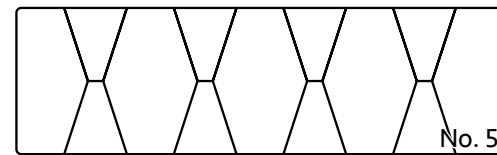
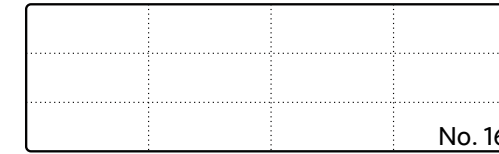
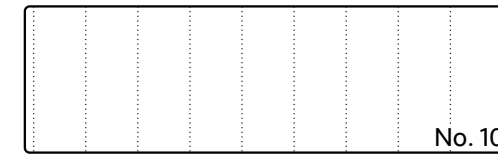
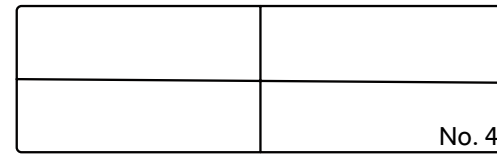
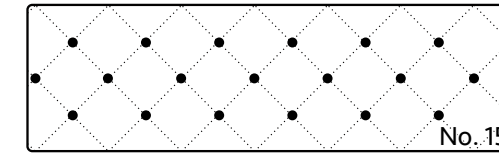
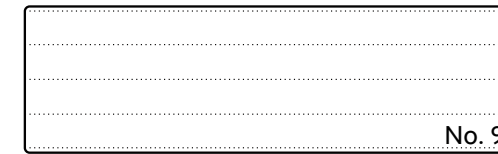
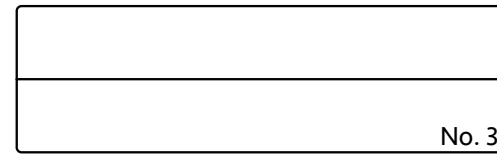
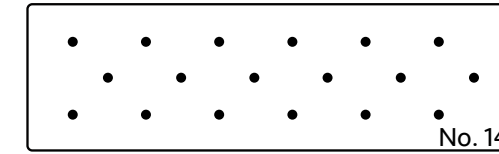
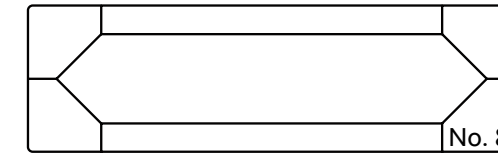
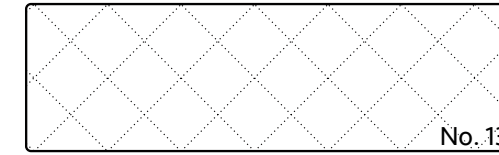
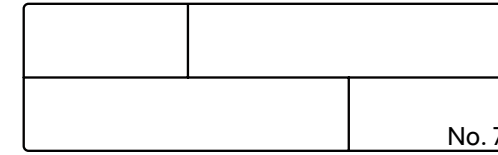
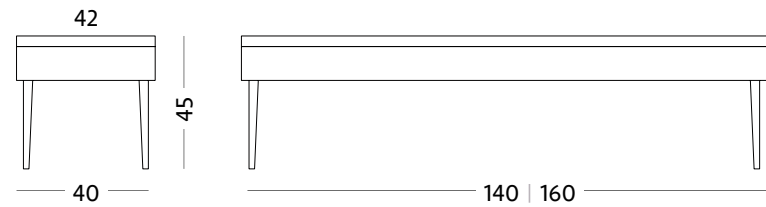
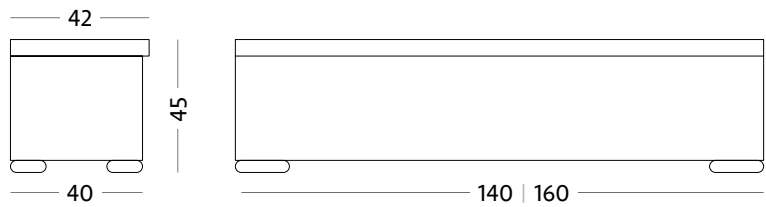

# Wood

Wood 1 (8, 10, 13 cm)



Wood 2 (8 cm)

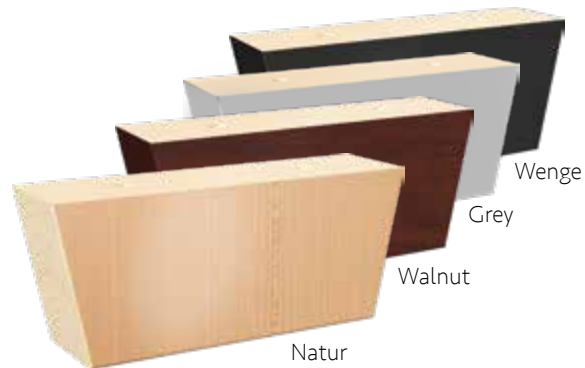

Wood 5 (11 cm)



Wood 4 (11 cm)



Tulip natur (13 cm)



Castello (13 cm)



Cube (10 cm)

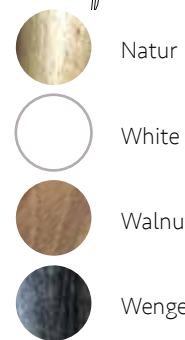
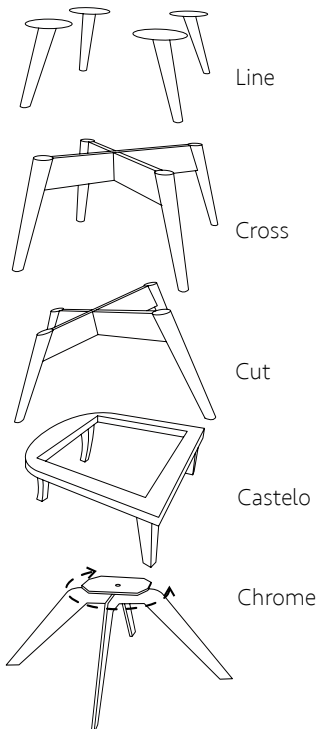

# Metal

Elegance (13 cm)



Chrome (11 cm)



Fancy (13 cm)



Polygon (10 cm)



Metal (8 cm)



Industry (13 cm)



Floor (3 cm)



Standard 2 (10 cm)

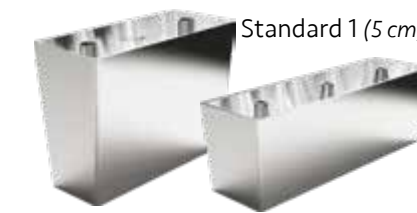

# Plastic

Obsah katalógu je duševným vlastníctvom firmy Materasso Slovakia s. r. o.  
Použití tieto materiály je možné len s uvedením ich vlastníka: © **Materasso Slovakia s.r.o.**  
Nedodržanie týchto podmienok je právne **vymáhatelné ako porušenie autorských práv.**

Obsah katalogu je duševním vlastníctvím firmy Materasso Slovakia s. r. o.  
Použití tyto materiály lze pouze s uvedením jejich vlastníka: © **Materasso Slovakia s.r.o.**  
Nedodržení těchto podmínek je právne **vymáhatelné jako porušení autorských práv.**

The content of the catalogue is the intellectual property of Materasso Slovakia s. r. o.  
It is possible to use these materials only with the indication of their owner: © **Materasso Slovakia s.r.o.**  
Failure to comply with these terms and conditions is legally **enforceable as copyright infringement.**

Zawartość katalogu jest własnością intelektualną Materasso Slovakia s. r. o.  
Korzystanie z tych materiałów jest możliwe tylko za wskazaniem ich właściciela: © **Materasso Slovakia s.r.o.**  
Nieprzestrzeganie tych warunków jest prawnie **egzekwowalne jako naruszenie praw autorskich.**

El contenido del catálogo es propiedad intelectual de Materasso Slovakia s. r. o.  
Es posible utilizar estos materiales solo con la indicación de su propietario: © **Materasso Slovakia s.r.o.**  
El incumplimiento de estos términos y condiciones es **legalmente exigible como infracción de los derechos de autor.**

Der Inhalt des Katalogs ist geistiges Eigentum von Materasso Slovakia s. r. o.  
Die Nutzung dieser Materialien ist nur mit Angabe des Eigentümers möglich: © **Materasso Slovakia s.r.o.**  
Die Nichteinhaltung dieser Bestimmungen und Bedingungen kann als **Urheberrechtsverletzung rechtlich verfolgt werden.**



Farby použitých materiálov sú ilustračné, môžu byť odlišné od skutočnosti.

Barvy použitých materiálů jsou ilustrační, mohou být odlišné od skutečnosti.

The colors of the materials used are illustrative, they may differ from the actual ones.

Kolory użytych materiałów mają charakter poglądowy, mogą różnić się od rzeczywistych.

Los colores de los materiales utilizados son ilustrativos, pueden diferir de los reales.

Die Farben der verwendeten Materialien sind illustrativ, sie können von den tatsächlichen abweichen.

